

STARPOWER

SEMICONDUCTOR

IGBT

GD25PJA120L3S_B20

1200V/25A PIM in one-package

General Description

STARPOWER IGBT Power Module provides ultra low conduction loss as well as short circuit ruggedness. They are designed for the applications such as general inverters and UPS.

Features

- Low $V_{CE(sat)}$ Trench IGBT technology
- 8 μ s short circuit capability
- $V_{CE(sat)}$ with positive temperature coefficient
- Maximum junction temperature 175°C
- Low inductance case
- Fast & soft reverse recovery anti-parallel FWD
- Isolated heatsink using DBC technology

Typical Applications

- Inverter for motor drive
- AC and DC servo drive amplifier
- Uninterruptible power supply

Equivalent Circuit Schematic

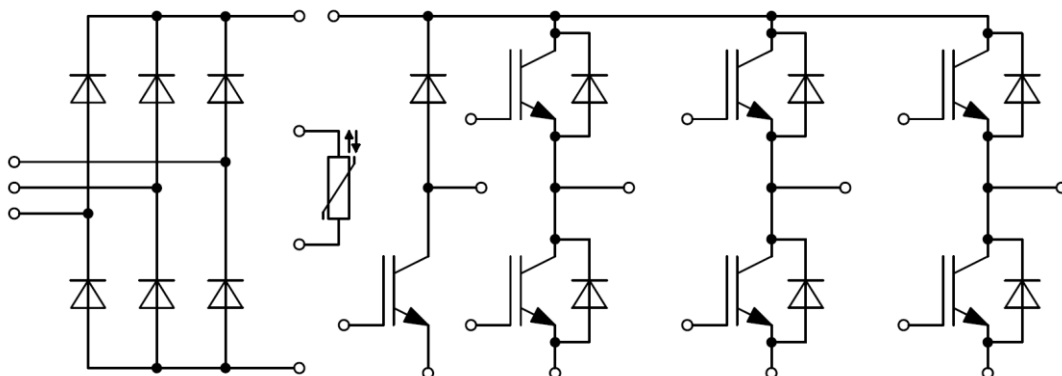

Absolute Maximum Ratings $T_H=25^{\circ}\text{C}$ unless otherwise noted**IGBT-inverter**

Symbol	Description	Value	Unit
V_{CES}	Collector-Emitter Voltage	1200	V
V_{GES}	Gate-Emitter Voltage	± 20	V
I_C	Collector Current @ $T_H=100^{\circ}\text{C}$	25	A
I_{CM}	Pulsed Collector Current $t_p=1\text{ms}$	50	A

Diode-inverter

Symbol	Description	Value	Unit
V_{RRM}	Repetitive Peak Reverse Voltage	1200	V
I_F	Diode Continuous Forward Current	25	A
I_{FM}	Diode Maximum Forward Current $t_p=1\text{ms}$	50	A
I_{FSM}	Surge Forward Current $t_p=10\text{ms}$ @ $T_{vj}=125^{\circ}\text{C}$ @ $T_{vj}=150^{\circ}\text{C}$	121	A
		112	
I^2t	I^2t -value, $t_p=10\text{ms}$ @ $T_{vj}=125^{\circ}\text{C}$ @ $T_{vj}=150^{\circ}\text{C}$	73	A^2s
		63	

Diode-rectifier

Symbol	Description	Value	Unit
V_{RRM}	Repetitive Peak Reverse Voltage	1600	V
I_{FRMSM}	Maximum RMS Forward Current per Chip @ $T_H=100^{\circ}\text{C}$	45	A
I_{RMSM}	Maximum RMS Current at Rectifier Output @ $T_H=100^{\circ}\text{C}$	50	A
I_{FSM}	Surge Forward Current $t_p=10\text{ms}$ @ $T_{vj}=25^{\circ}\text{C}$ @ $T_{vj}=150^{\circ}\text{C}$	450	A
		370	
I^2t	I^2t -value, $t_p=10\text{ms}$ @ $T_{vj}=25^{\circ}\text{C}$ @ $T_{vj}=150^{\circ}\text{C}$	1000	A^2s
		685	

IGBT-brake

Symbol	Description	Value	Unit
V_{CES}	Collector-Emitter Voltage	1200	V
V_{GES}	Gate-Emitter Voltage	± 20	V
I_C	Collector Current @ $T_H=100^{\circ}\text{C}$	25	A
I_{CM}	Pulsed Collector Current $t_p=1\text{ms}$	50	A

Diode-brake

Symbol	Description	Value	Unit
V_{RRM}	Repetitive Peak Reverse Voltage	1200	V
I_F	Diode Continuous Forward Current	10	A
I_{FM}	Diode Maximum Forward Current $t_p=1\text{ms}$	20	A
I_{FSM}	Surge Forward Current $t_p=10\text{ms}$ @ $T_{vj}=125^{\circ}\text{C}$ @ $T_{vj}=150^{\circ}\text{C}$	37	A
		38	
I^2t	I^2t -value, $t_p=10\text{ms}$ @ $T_{vj}=125^{\circ}\text{C}$ @ $T_{vj}=150^{\circ}\text{C}$	7	A^2s
		7	

Module

Symbol	Description	Value	Unit
T_{vjmax}	Maximum Junction Temperature(inverter,brake)	175	°C
	Maximum Junction Temperature (rectifier)	150	
T_{vjop}	Operating Junction Temperature	-40 to +150	°C
T_{STG}	Storage Temperature Range	-40 to +125	°C
V_{ISO}	Isolation Voltage RMS,f=50Hz,t=1 min	2500	V

IGBT-inverter Characteristics $T_H=25^\circ\text{C}$ unless otherwise noted

Symbol	Parameter	Test Conditions	Min.	Typ.	Max.	Unit
$V_{CE(sat)}$	Collector to Emitter Saturation Voltage	$I_C=25\text{A}, V_{GE}=15\text{V}, T_{vj}=25^\circ\text{C}$		1.50	1.95	V
		$I_C=25\text{A}, V_{GE}=15\text{V}, T_{vj}=125^\circ\text{C}$		1.70		
		$I_C=25\text{A}, V_{GE}=15\text{V}, T_{vj}=150^\circ\text{C}$		1.80		
$V_{GE(th)}$	Gate-Emitter Threshold Voltage	$I_C=0.50\text{mA}, V_{CE}=V_{GE}, T_{vj}=25^\circ\text{C}$	5.4	6.2	7.0	V
I_{CES}	Collector Cut-Off Current	$V_{CE}=V_{CES}, V_{GE}=0\text{V}, T_{vj}=25^\circ\text{C}$			50	μA
I_{GES}	Gate-Emitter Leakage Current	$V_{GE}=V_{GES}, V_{CE}=0\text{V}, T_{vj}=25^\circ\text{C}$			100	nA
R_{Gint}	Internal Gate Resistance			0		Ω
C_{ies}	Input Capacitance	$V_{CE}=25\text{V}, f=1\text{MHz}, V_{GE}=0\text{V}$		2.21		nF
C_{res}	Reverse Transfer Capacitance				0.02	
Q_G	Gate Charge	$V_{GE}=-15\dots+15\text{V}$		0.16		μC
$t_{d(on)}$	Turn-On Delay Time	$V_{CC}=600\text{V}, I_C=25\text{A}, R_G=20\Omega, L_S=35\text{nH}, V_{GE}=\pm 15\text{V}, T_{vj}=25^\circ\text{C}$		27		ns
t_r	Rise Time			26		ns
$t_{d(off)}$	Turn-Off Delay Time			219		ns
t_f	Fall Time			197		ns
E_{on}	Turn-On Switching Loss			2.00		mJ
E_{off}	Turn-Off Switching Loss			1.78		mJ
$t_{d(on)}$	Turn-On Delay Time	$V_{CC}=600\text{V}, I_C=25\text{A}, R_G=20\Omega, L_S=35\text{nH}, V_{GE}=\pm 15\text{V}, T_{vj}=125^\circ\text{C}$		28		ns
t_r	Rise Time			29		ns
$t_{d(off)}$	Turn-Off Delay Time			258		ns
t_f	Fall Time			294		ns
E_{on}	Turn-On Switching Loss			2.56		mJ
E_{off}	Turn-Off Switching Loss			2.45		mJ
$t_{d(on)}$	Turn-On Delay Time	$V_{CC}=600\text{V}, I_C=25\text{A}, R_G=20\Omega, L_S=35\text{nH}, V_{GE}=\pm 15\text{V}, T_{vj}=150^\circ\text{C}$		30		ns
t_r	Rise Time			30		ns
$t_{d(off)}$	Turn-Off Delay Time			272		ns
t_f	Fall Time			329		ns
E_{on}	Turn-On Switching Loss			2.76		mJ
E_{off}	Turn-Off Switching Loss			2.62		mJ
I_{SC}	SC Data	$t_p \leq 8\mu\text{s}, V_{GE}=15\text{V}, T_{vj}=150^\circ\text{C}, V_{CC}=600\text{V}, V_{CEM} \leq 1200\text{V}$		75		A

Diode-inverter Characteristics $T_H=25^{\circ}\text{C}$ unless otherwise noted

Symbol	Parameter	Test Conditions	Min.	Typ.	Max.	Unit
V_F	Diode Forward Voltage	$I_F=25\text{A}, V_{GE}=0\text{V}, T_{vj}=25^{\circ}\text{C}$		1.60	2.05	V
		$I_F=25\text{A}, V_{GE}=0\text{V}, T_{vj}=125^{\circ}\text{C}$		1.65		
		$I_F=25\text{A}, V_{GE}=0\text{V}, T_{vj}=150^{\circ}\text{C}$		1.65		
Q_r	Recovered Charge	$V_R=600\text{V}, I_F=25\text{A},$ $-di/dt=986\text{A}/\mu\text{s}, L_S=35\text{nH},$ $V_{GE}=-15\text{V}, T_{vj}=25^{\circ}\text{C}$		2.40		μC
I_{RM}	Peak Reverse Recovery Current			27		A
E_{rec}	Reverse Recovery Energy			0.73		mJ
Q_r	Recovered Charge	$V_R=600\text{V}, I_F=25\text{A},$ $-di/dt=892\text{A}/\mu\text{s}, L_S=35\text{nH},$ $V_{GE}=-15\text{V}, T_{vj}=125^{\circ}\text{C}$		4.03		μC
I_{RM}	Peak Reverse Recovery Current			28		A
E_{rec}	Reverse Recovery Energy			1.44		mJ
Q_r	Recovered Charge	$V_R=600\text{V}, I_F=25\text{A},$ $-di/dt=866\text{A}/\mu\text{s}, L_S=35\text{nH},$ $V_{GE}=-15\text{V}, T_{vj}=150^{\circ}\text{C}$		4.43		μC
I_{RM}	Peak Reverse Recovery Current			29		A
E_{rec}	Reverse Recovery Energy			1.60		mJ

Diode-rectifier Characteristics $T_H=25^{\circ}\text{C}$ unless otherwise noted

Symbol	Parameter	Test Conditions	Min.	Typ.	Max.	Unit
V_F	Diode Forward Voltage	$I_F=25\text{A}, V_{GE}=0\text{V}, T_{vj}=150^{\circ}\text{C}$		0.85		V
I_R	Reverse Current	$T_{vj}=150^{\circ}\text{C}, V_R=1600\text{V}$			2.0	mA

IGBT-brake Characteristics $T_H=25^{\circ}\text{C}$ unless otherwise noted

Symbol	Parameter	Test Conditions	Min.	Typ.	Max.	Unit
$V_{CE(sat)}$	Collector to Emitter Saturation Voltage	$I_C=25\text{A}, V_{GE}=15\text{V}, T_{vj}=25^{\circ}\text{C}$		1.50	1.95	V
		$I_C=25\text{A}, V_{GE}=15\text{V}, T_{vj}=125^{\circ}\text{C}$		1.70		
		$I_C=25\text{A}, V_{GE}=15\text{V}, T_{vj}=150^{\circ}\text{C}$		1.80		
$V_{GE(th)}$	Gate-Emitter Threshold Voltage	$I_C=0.50\text{mA}, V_{CE}=V_{GE}, T_{vj}=25^{\circ}\text{C}$	5.4	6.2	7.0	V
I_{CES}	Collector Cut-Off Current	$V_{CE}=V_{CES}, V_{GE}=0\text{V}, T_{vj}=25^{\circ}\text{C}$			50	μA
I_{GES}	Gate-Emitter Leakage Current	$V_{GE}=V_{GES}, V_{CE}=0\text{V}, T_{vj}=25^{\circ}\text{C}$			100	nA
R_{Gint}	Internal Gate Resistance			0		Ω
C_{ies}	Input Capacitance	$V_{CE}=25\text{V}, f=1\text{MHz}, V_{GE}=0\text{V}$		2.21		nF
C_{res}	Reverse Transfer Capacitance				0.02	
Q_G	Gate Charge	$V_{GE}=-15\dots+15\text{V}$		0.16		μC
$t_{d(on)}$	Turn-On Delay Time	$V_{CC}=600\text{V}, I_C=25\text{A}, R_G=20\Omega, L_S=35\text{nH}, V_{GE}=\pm 15\text{V}, T_{vj}=25^{\circ}\text{C}$		27		ns
t_r	Rise Time			26		ns
$t_{d(off)}$	Turn-Off Delay Time			219		ns
t_f	Fall Time			197		ns
E_{on}	Turn-On Switching Loss			2.00		mJ
E_{off}	Turn-Off Switching Loss			1.78		mJ
$t_{d(on)}$	Turn-On Delay Time	$V_{CC}=600\text{V}, I_C=25\text{A}, R_G=20\Omega, L_S=35\text{nH}, V_{GE}=\pm 15\text{V}, T_{vj}=125^{\circ}\text{C}$		28		ns
t_r	Rise Time			29		ns
$t_{d(off)}$	Turn-Off Delay Time			258		ns
t_f	Fall Time			294		ns
E_{on}	Turn-On Switching Loss			2.56		mJ
E_{off}	Turn-Off Switching Loss			2.45		mJ
$t_{d(on)}$	Turn-On Delay Time	$V_{CC}=600\text{V}, I_C=25\text{A}, R_G=20\Omega, L_S=35\text{nH}, V_{GE}=\pm 15\text{V}, T_{vj}=150^{\circ}\text{C}$		30		ns
t_r	Rise Time			30		ns
$t_{d(off)}$	Turn-Off Delay Time			272		ns
t_f	Fall Time			329		ns
E_{on}	Turn-On Switching Loss			2.76		mJ
E_{off}	Turn-Off Switching Loss			2.62		mJ
I_{SC}	SC Data	$t_p \leq 8\mu\text{s}, V_{GE}=15\text{V}, T_{vj}=150^{\circ}\text{C}, V_{CC}=600\text{V}, V_{CEM} \leq 1200\text{V}$		75		A

Diode-brake Characteristics $T_H=25^{\circ}\text{C}$ unless otherwise noted

Symbol	Parameter	Test Conditions	Min.	Typ.	Max.	Unit
V_F	Diode Forward Voltage	$I_F=10\text{A}, V_{GE}=0\text{V}, T_{vj}=25^{\circ}\text{C}$		1.60	2.05	V
		$I_F=10\text{A}, V_{GE}=0\text{V}, T_{vj}=125^{\circ}\text{C}$		1.65		
		$I_F=10\text{A}, V_{GE}=0\text{V}, T_{vj}=150^{\circ}\text{C}$		1.65		

NTC Characteristics $T_H=25^{\circ}\text{C}$ unless otherwise noted

Symbol	Parameter	Test Conditions	Min.	Typ.	Max.	Unit
R_{25}	Rated Resistance			5.0		k Ω
$\Delta R/R$	Deviation of R_{100}	$T_C=100^{\circ}\text{C}, R_{100}=493.3\Omega$	-5		5	%
P_{25}	Power Dissipation				20.0	mW
$B_{25/50}$	B-value	$R_2=R_{25}\exp[B_{25/50}(1/T_2-1/(298.15\text{K}))]$		3375		K
$B_{25/80}$	B-value	$R_2=R_{25}\exp[B_{25/80}(1/T_2-1/(298.15\text{K}))]$		3411		K
$B_{25/100}$	B-value	$R_2=R_{25}\exp[B_{25/100}(1/T_2-1/(298.15\text{K}))]$		3433		K

Module Characteristics $T_H=25^{\circ}\text{C}$ unless otherwise noted

Symbol	Parameter	Min.	Typ.	Max.	Unit
L_{CE}	Stray Inductance		30		nH
$R_{CC'+EE'}$ $R_{AA'+CC'}$	Module Lead Resistance, Terminal to Chip		5.00 6.00		m Ω
R_{thJH}	Junction-to-Heatsink (per IGBT-inverter)		1.250		K/W
	Junction-to-Heatsink (per Diode-inverter)		1.730		
	Junction-to-Heatsink (per Diode-rectifier)		1.360		
	Junction-to-Heatsink (per IGBT-brake)		1.250		
	Junction-to-Heatsink (per Diode-brake)		2.440		
F	Mounting Force Per Clamp	40		80	N
G	Weight of Module		39		g

Internal Isolation	Basic Insulation (class 1, IEC 61140)		Al_2O_3	
Creepage Distance	Terminal to Heatsink		11.5	mm
	Terminal to Terminal		6.30	
Clearance	Terminal to Heatsink		10.0	mm
	Terminal to Terminal		5.00	
Comperative Tracking Index		CTI	> 175	

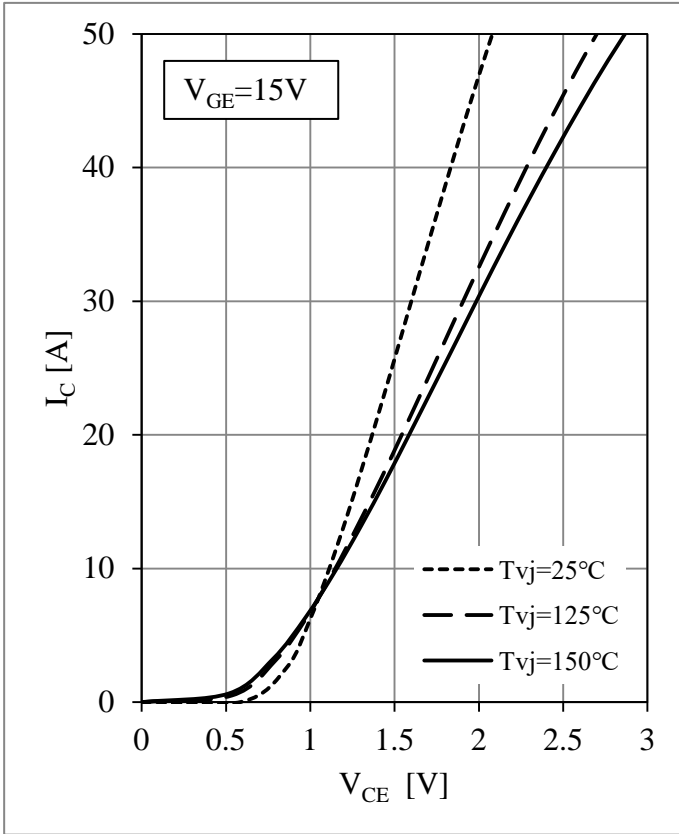

Fig 1. IGBT-inverter Output Characteristics

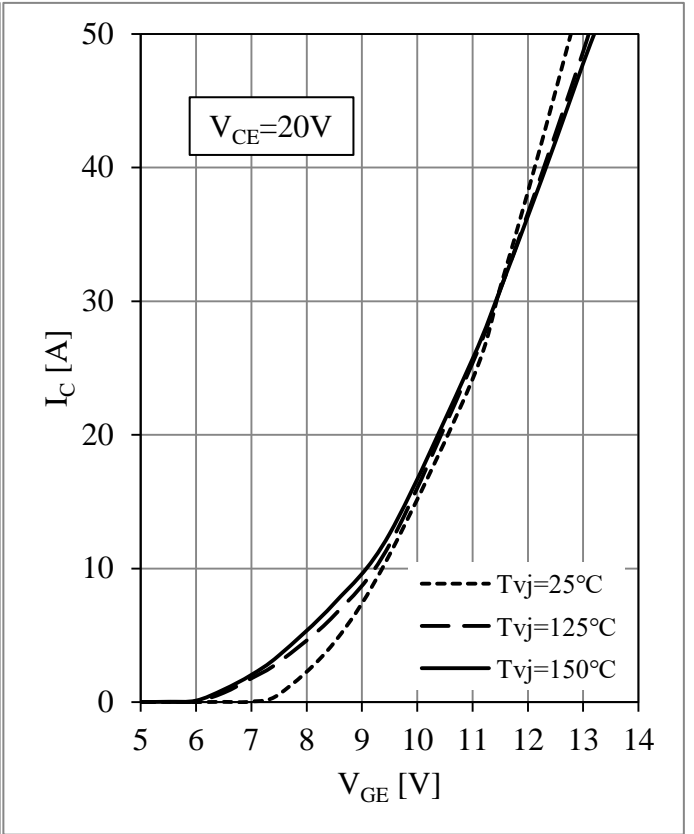

Fig 2. IGBT-inverter Transfer Characteristics

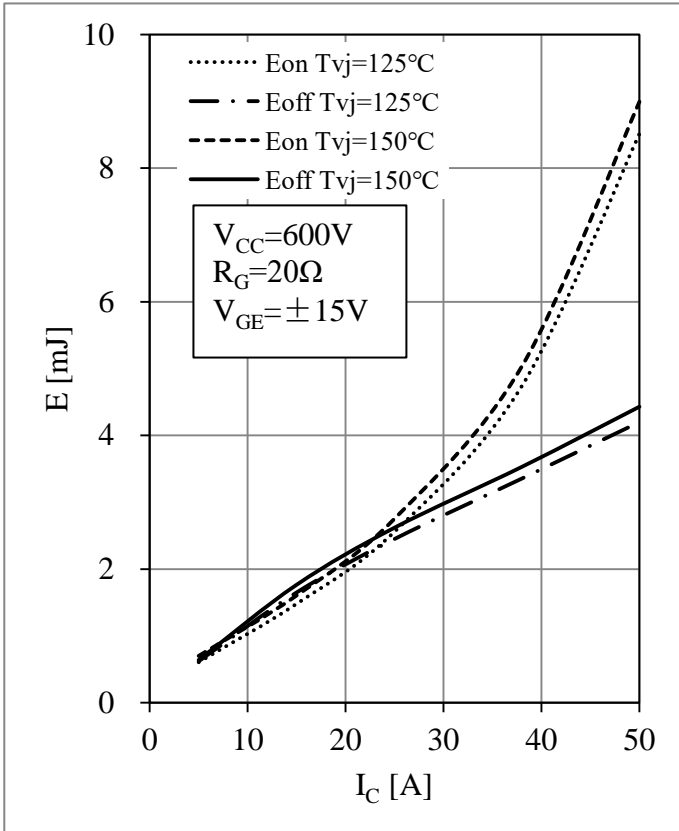

Fig 3. IGBT-inverter Switching Loss vs. I_C

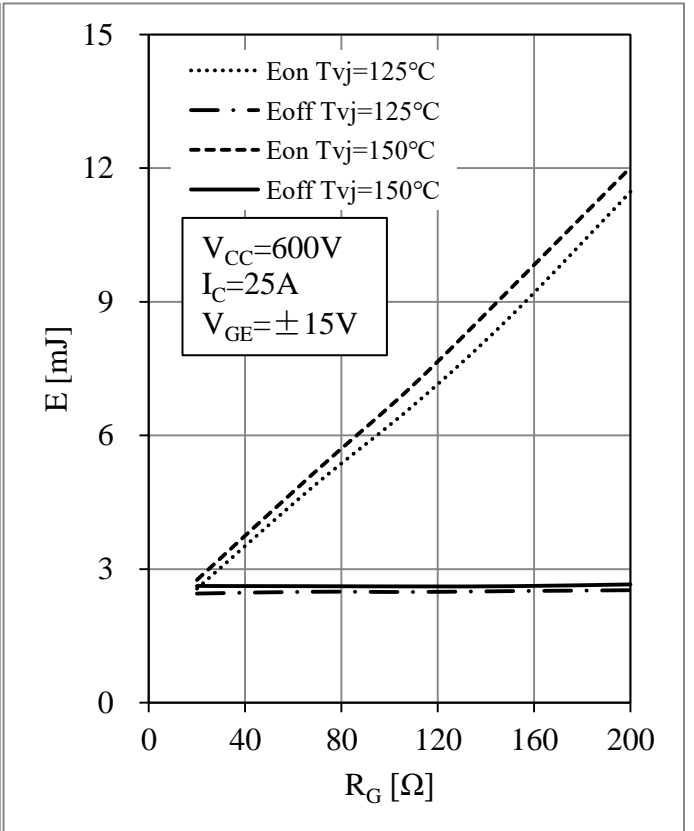

Fig 4. IGBT-inverter Switching Loss vs. R_G

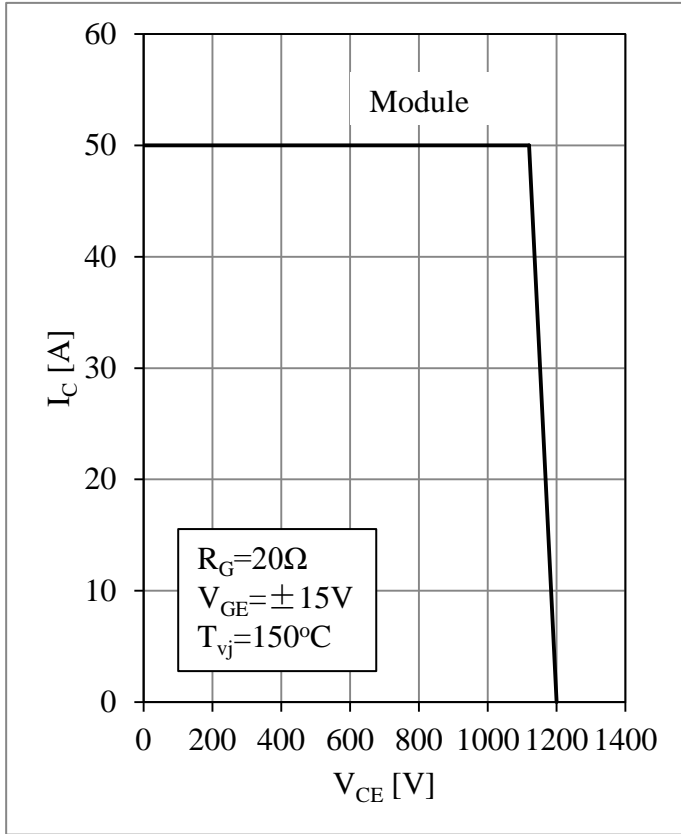

Fig 5. IGBT-inverter RBSOA

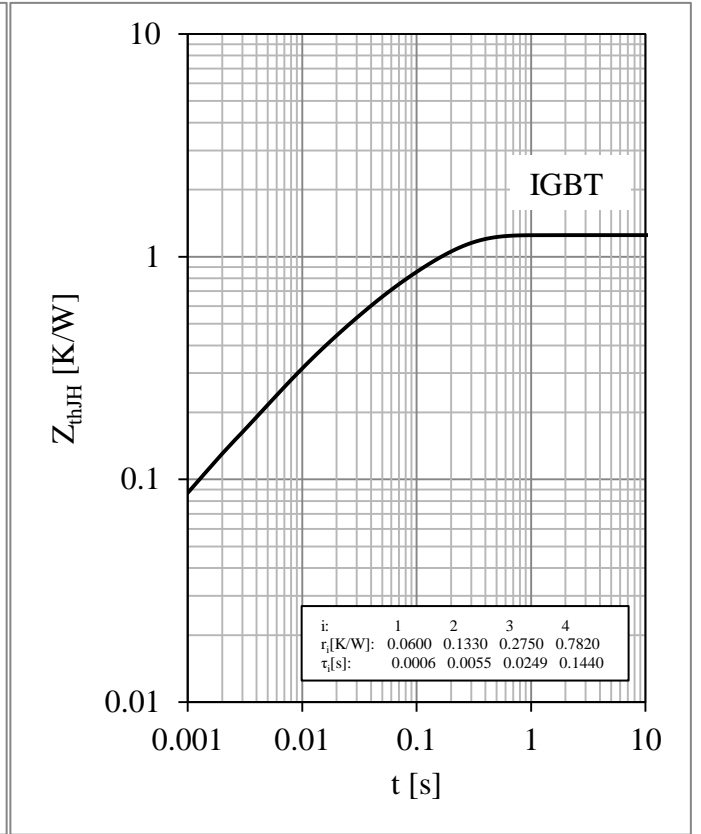

Fig 6. IGBT-inverter Transient Thermal Impedance

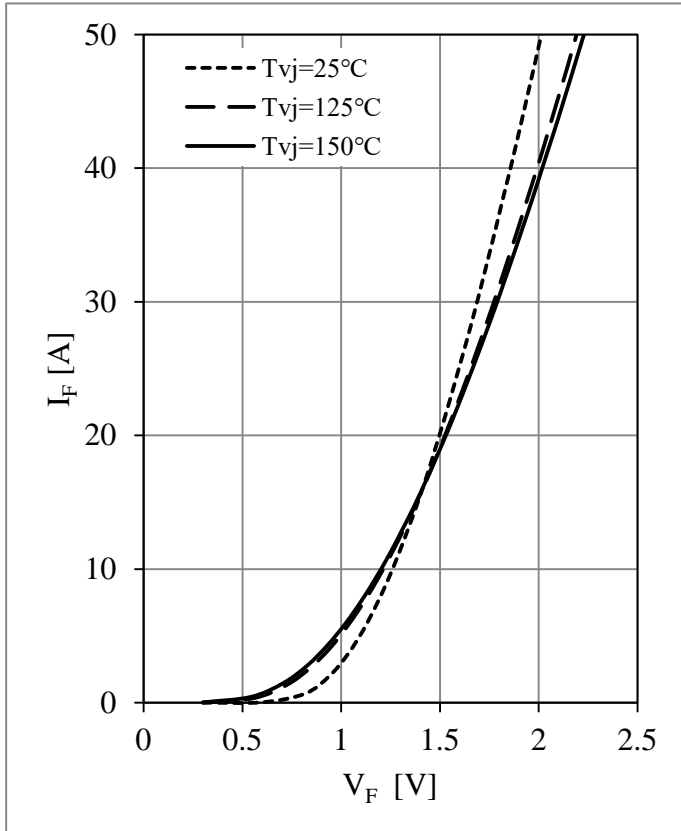

Fig 7. Diode-inverter Forward Characteristics

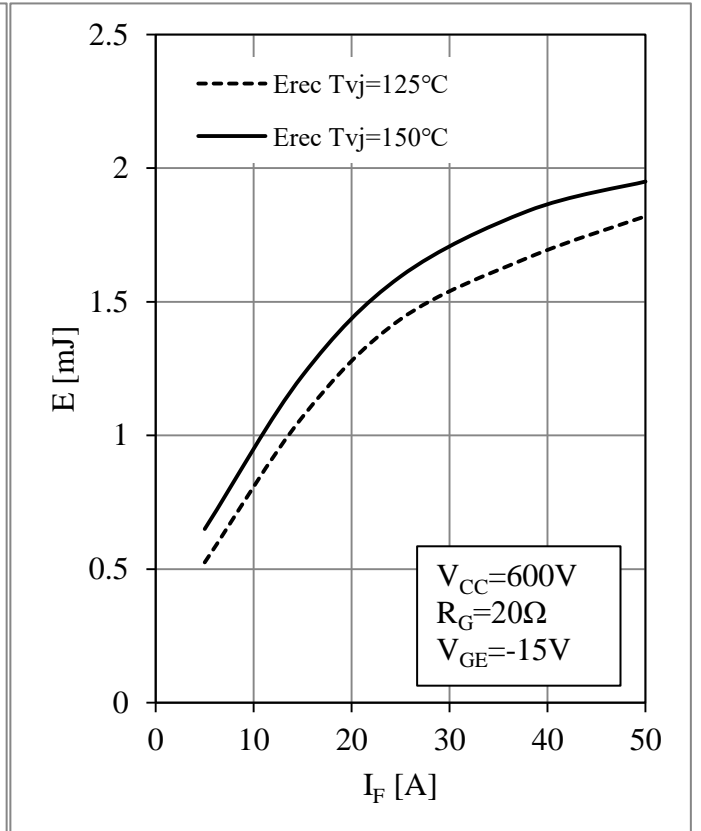

Fig 8. Diode-inverter Switching Loss vs. I_F

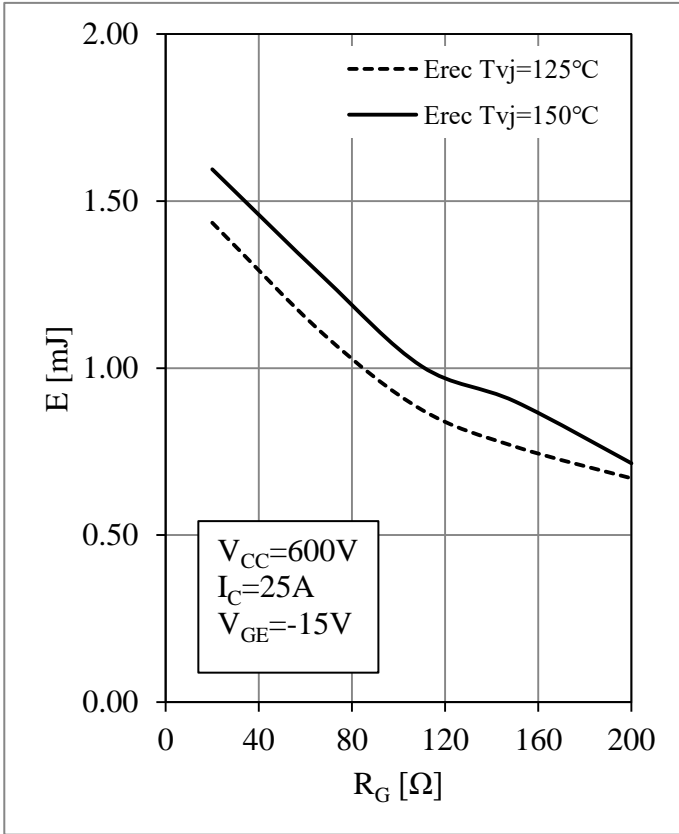

Fig 9. Diode-inverter Switching Loss vs. R_G

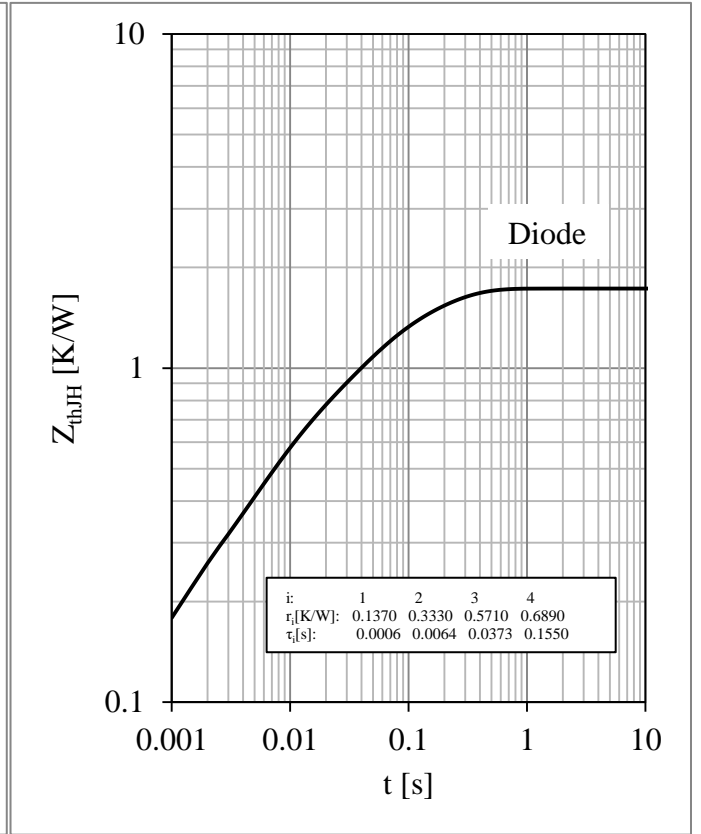

Fig 10. Diode-inverter Transient Thermal Impedance

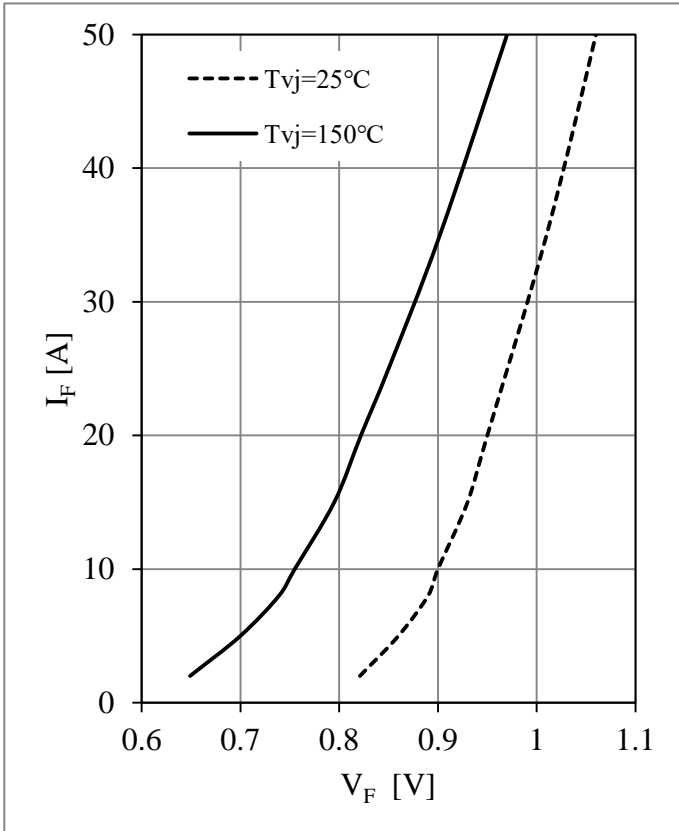

Fig 11. Diode-rectifier Forward Characteristics

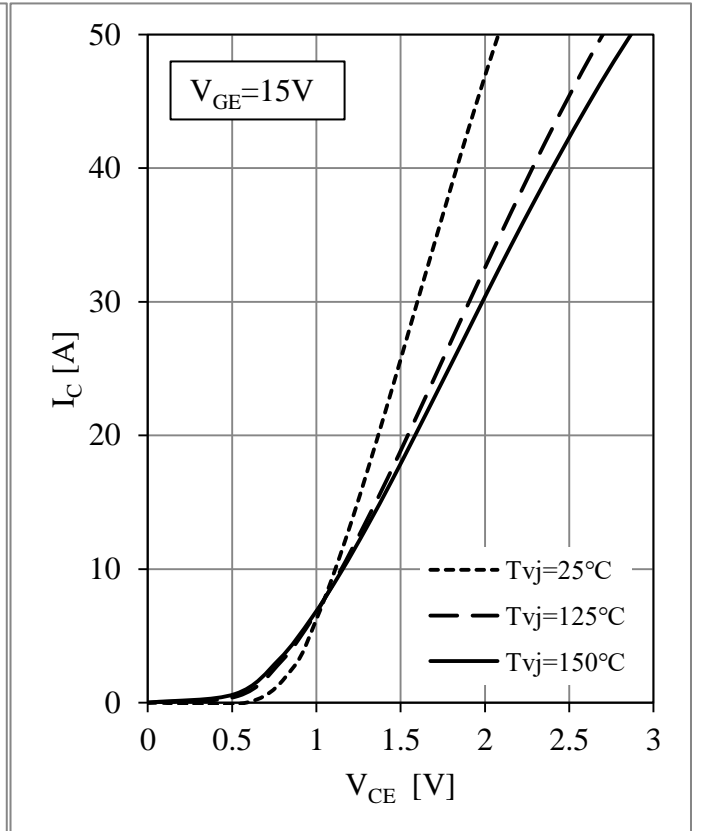

Fig 12. IGBT-brake-chopper Output Characteristics

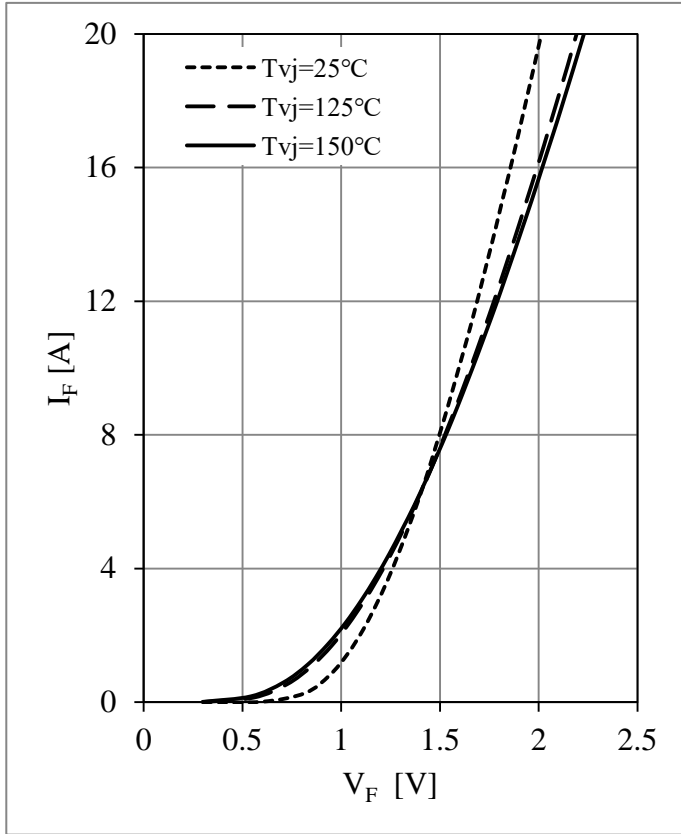

Fig 13. Diode-brake-chopper Forward Characteristics

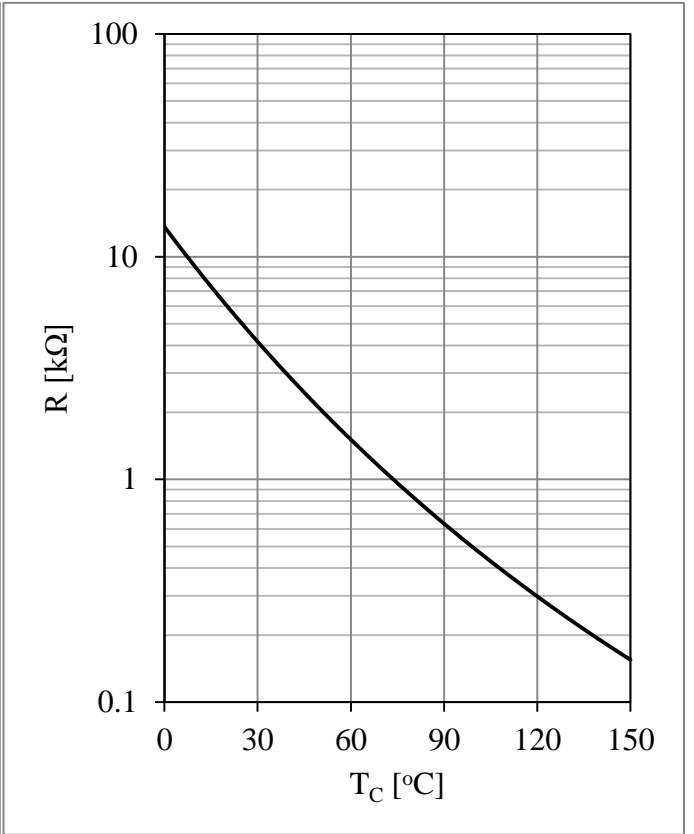
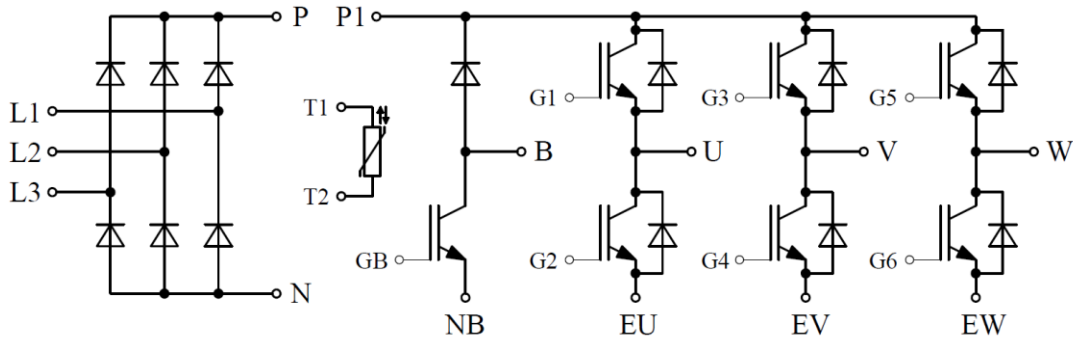

Fig 14. NTC Temperature Characteristic

Circuit Schematic



Package Dimensions

Dimensions in Millimeters

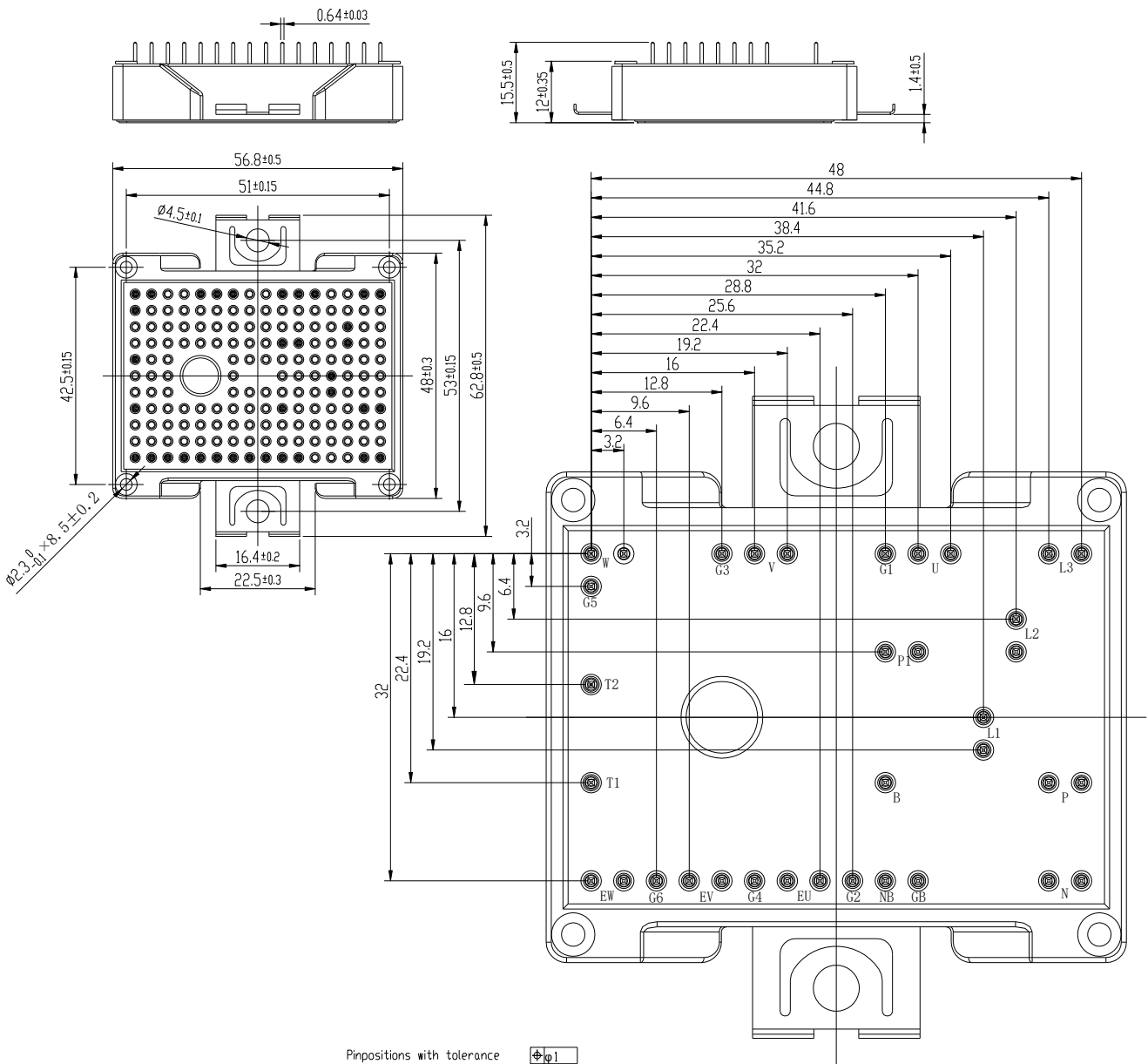

Terms and Conditions of Usage

The data contained in this product datasheet is exclusively intended for technically trained staff. you and your technical departments will have to evaluate the suitability of the product for the intended application and the completeness of the product data with respect to such application.

This product data sheet is describing the characteristics of this product for which a warranty is granted. Any such warranty is granted exclusively pursuant the terms and conditions of the supply agreement. There will be no guarantee of any kind for the product and its characteristics.

Should you require product information in excess of the data given in this product data sheet or which concerns the specific application of our product, please contact the sales office, which is responsible for you (see www.powersemi.cc), For those that are specifically interested we may provide application notes.

Due to technical requirements our product may contain dangerous substances. For information on the types in question please contact the sales office, which is responsible for you.

Should you intend to use the Product in aviation applications, in health or live endangering or life support applications, please notify.

If and to the extent necessary, please forward equivalent notices to your customers.
Changes of this product data sheet are reserved.