

STARPOWER

SEMICONDUCTOR

IGBT

GD630HTA75P8HT

750V/630A 6 in one-package

General Description

STARPOWER IGBT Power Module provides ultra low conduction loss as well as short circuit ruggedness. They are designed for the applications such as hybrid and electric vehicle.

Features

- Low $V_{CE(sat)}$ Trench IGBT technology
- Low switching losses
- 6 μ s short circuit capability
- $V_{CE(sat)}$ with positive temperature coefficient
- Maximum junction temperature 175°C
- Low inductance case
- Fast & soft reverse recovery anti-parallel FWD
- Isolated copper pinfin baseplate using Si₃N₄ AMB technology

Typical Applications

- Automotive application
- Hybrid and electric vehicle
- Inverter for motor drive

Equivalent Circuit Schematic

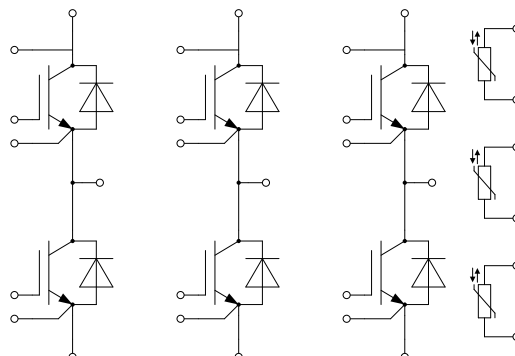

Absolute Maximum Ratings $T_F=25^{\circ}\text{C}$ unless otherwise noted**IGBT**

Symbol	Description	Values	Unit
V_{CES}	Collector-Emitter Voltage	750	V
V_{GES}	Gate-Emitter Voltage	± 20	V
I_{CN}	Implemented Collector Current	630	A
I_C	Collector Current @ $T_F=75^{\circ}\text{C}$	420	A
I_{CRM}	Repetitive Peak Collector Current tp limited by T_{vjop}	1260	A
P_D	Maximum Power Dissipation @ $T_F=75^{\circ}\text{C}$ $T_{vj}=175^{\circ}\text{C}$	746	W

Diode

Symbol	Description	Values	Unit
V_{RRM}	Repetitive Peak Reverse Voltage	750	V
I_{FN}	Implemented Collector Current	630	A
I_F	Diode Continuous Forward Current	420	A
I_{FRM}	Repetitive Peak Forward Current tp limited by T_{vjop}	1260	A

Module

Symbol	Description	Value	Unit
T_{vjmax}	Maximum Junction Temperature	175	$^{\circ}\text{C}$
T_{vjop}	Operating Junction Temperature continuous	-40 to +175	$^{\circ}\text{C}$
T_{STG}	Storage Temperature Range	-40 to +125	$^{\circ}\text{C}$
V_{ISO}	Isolation Voltage RMS, $f=50\text{Hz}$, $t=1\text{min}$	2500	V

IGBT Characteristics $T_F=25^\circ\text{C}$ unless otherwise noted

Symbol	Parameter	Test Conditions	Min.	Typ.	Max.	Unit	
$V_{CE(sat)}$	Collector to Emitter Saturation Voltage	$I_C=420\text{A}, V_{GE}=15\text{V}, T_{vj}=25^\circ\text{C}$		1.20	1.65	V	
		$I_C=420\text{A}, V_{GE}=15\text{V}, T_{vj}=150^\circ\text{C}$		1.25			
		$I_C=420\text{A}, V_{GE}=15\text{V}, T_{vj}=175^\circ\text{C}$		1.30			
		$I_C=630\text{A}, V_{GE}=15\text{V}, T_{vj}=25^\circ\text{C}$		1.35			
		$I_C=630\text{A}, V_{GE}=15\text{V}, T_{vj}=175^\circ\text{C}$		1.55			
$V_{GE(th)}$	Gate-Emitter Threshold Voltage	$I_C=8.60\text{mA}, V_{CE}=V_{GE}, T_{vj}=25^\circ\text{C}$	5.7	6.5	7.4	V	
I_{CES}	Collector Cut-Off Current	$V_{CE}=V_{CES}, V_{GE}=0\text{V}, T_{vj}=25^\circ\text{C}$			1.0	mA	
I_{GES}	Gate-Emitter Leakage Current	$V_{GE}=V_{GES}, V_{CE}=0\text{V}, T_{vj}=25^\circ\text{C}$			400	nA	
R_{Gint}	Internal Gate Resistance			1.7		Ω	
C_{ies}	Input Capacitance			28.7		nF	
C_{oes}	Output Capacitance	$V_{CE}=50\text{V}, f=100\text{kHz}, V_{GE}=0\text{V}$		1.00		nF	
C_{res}	Reverse Transfer Capacitance	$V_{GE}=0\text{V}$		0.12		nF	
Q_G	Gate Charge	$V_{CE}=400\text{V}, I_C=540\text{A}, V_{GE}=-15\dots+15\text{V}$		1.63		μC	
$t_{d(on)}$	Turn-On Delay Time	$V_{CC}=450\text{V}, I_C=420\text{A}, R_{Gon}=3.6\Omega, R_{Goff}=7.5\Omega, L_S=20\text{nH}, V_{GE}=-8/+15\text{V}, T_{vj}=25^\circ\text{C}$		199		ns	
t_r	Rise Time			57		ns	
$t_{d(off)}$	Turn-Off Delay Time			673		ns	
t_f	Fall Time			116		ns	
E_{on}	Turn-On Switching Loss			11.3		mJ	
E_{off}	Turn-Off Switching Loss			21.0		mJ	
$t_{d(on)}$	Turn-On Delay Time		$V_{CC}=450\text{V}, I_C=420\text{A}, R_{Gon}=3.6\Omega, R_{Goff}=7.5\Omega, L_S=20\text{nH}, V_{GE}=-8/+15\text{V}, T_{vj}=150^\circ\text{C}$		208		ns
t_r	Rise Time				65		ns
$t_{d(off)}$	Turn-Off Delay Time				737		ns
t_f	Fall Time				216		ns
E_{on}	Turn-On Switching Loss			17.1		mJ	
E_{off}	Turn-Off Switching Loss			31.4		mJ	
$t_{d(on)}$	Turn-On Delay Time	$V_{CC}=450\text{V}, I_C=420\text{A}, R_{Gon}=3.6\Omega, R_{Goff}=7.5\Omega, L_S=20\text{nH}, V_{GE}=-8/+15\text{V}, T_{vj}=175^\circ\text{C}$			212		ns
t_r	Rise Time				67		ns
$t_{d(off)}$	Turn-Off Delay Time				758		ns
t_f	Fall Time				236		ns
E_{on}	Turn-On Switching Loss			19.0		mJ	
E_{off}	Turn-Off Switching Loss			33.1		mJ	
I_{SC}	SC Data		$t_p \leq 6\mu\text{s}, V_{GE}=15\text{V}, T_{vj}=25^\circ\text{C}, V_{CC}=450\text{V}, V_{CEM} \leq 750\text{V}$		3400		A

		$t_p \leq 3\mu s, V_{GE}=15V,$ $T_{vj}=175^\circ C, V_{CC}=450V,$ $V_{CEM} \leq 750V$		2600		
--	--	---	--	------	--	--

Diode Characteristics $T_F=25^\circ C$ unless otherwise noted

Symbol	Parameter	Test Conditions	Min.	Typ.	Max.	Unit
V_F	Diode Forward Voltage	$I_F=420A, V_{GE}=0V, T_{vj}=25^\circ C$		1.55	2.00	V
		$I_F=420A, V_{GE}=0V, T_{vj}=150^\circ C$		1.55		
		$I_F=420A, V_{GE}=0V, T_{vj}=175^\circ C$		1.50		
		$I_F=630A, V_{GE}=0V, T_{vj}=25^\circ C$		1.75		
		$I_F=630A, V_{GE}=0V, T_{vj}=175^\circ C$		1.75		
Q_r	Recovered Charge			15.0		μC
I_{RM}	Peak Reverse Recovery Current	$V_R=450V, I_F=420A,$ $-di/dt=8203A/\mu s, L_S=20nH,$ $V_{GE}=-8V, T_{vj}=25^\circ C$		271		A
E_{rec}	Reverse Recovery Energy			3.33		mJ
Q_r	Recovered Charge			28.2		μC
I_{RM}	Peak Reverse Recovery Current	$V_R=450V, I_F=420A,$ $-di/dt=7182A/\mu s, L_S=20nH,$ $V_{GE}=-8V, T_{vj}=150^\circ C$		327		A
E_{rec}	Reverse Recovery Energy			6.92		mJ
Q_r	Recovered Charge			31.7		μC
I_{RM}	Peak Reverse Recovery Current	$V_R=450V, I_F=420A,$ $-di/dt=6918A/\mu s, L_S=20nH,$ $V_{GE}=-8V, T_{vj}=175^\circ C$		339		A
E_{rec}	Reverse Recovery Energy			7.78		mJ

NTC Characteristics $T_F=25^\circ C$ unless otherwise noted

Symbol	Parameter	Test Conditions	Min.	Typ.	Max.	Unit
R_{25}	Rated Resistance			5.0		k Ω
$\Delta R/R$	Deviation of R_{100}	$T_C=100^\circ C, R_{100}=493.3\Omega$	-5		5	%
P_{25}	Power Dissipation				20.0	mW
$B_{25/50}$	B-value	$R_2=R_{25}\exp[B_{25/50}(1/T_2-1/(298.15K))]$		3375		K
$B_{25/80}$	B-value	$R_2=R_{25}\exp[B_{25/80}(1/T_2-1/(298.15K))]$		3411		K
$B_{25/100}$	B-value	$R_2=R_{25}\exp[B_{25/100}(1/T_2-1/(298.15K))]$		3433		K

Module Characteristics $T_F=25^{\circ}\text{C}$ unless otherwise noted

Symbol	Parameter	Min.	Typ.	Max.	Unit
L_{CE}	Stray Inductance		13		nH
$R_{CC'+EE'}$	Module Lead Resistance, Terminal to Chip		0.83		m Ω
R_{thJF}	Junction-to-Cooling Fluid (per IGBT)		0.117	0.134	K/W
	Junction-to-Cooling Fluid (per Diode) $\Delta V/\Delta t=10.0\text{dm}^3/\text{min}, T_F=75^{\circ}\text{C}$		0.177	0.203	
G	Weight of Module		550		g

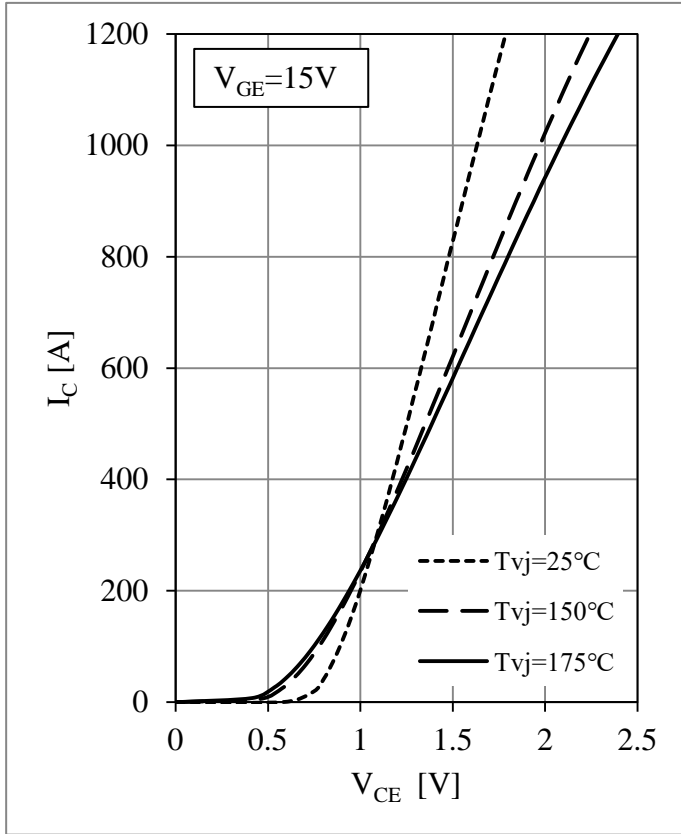

Fig 1. IGBT Output Characteristics

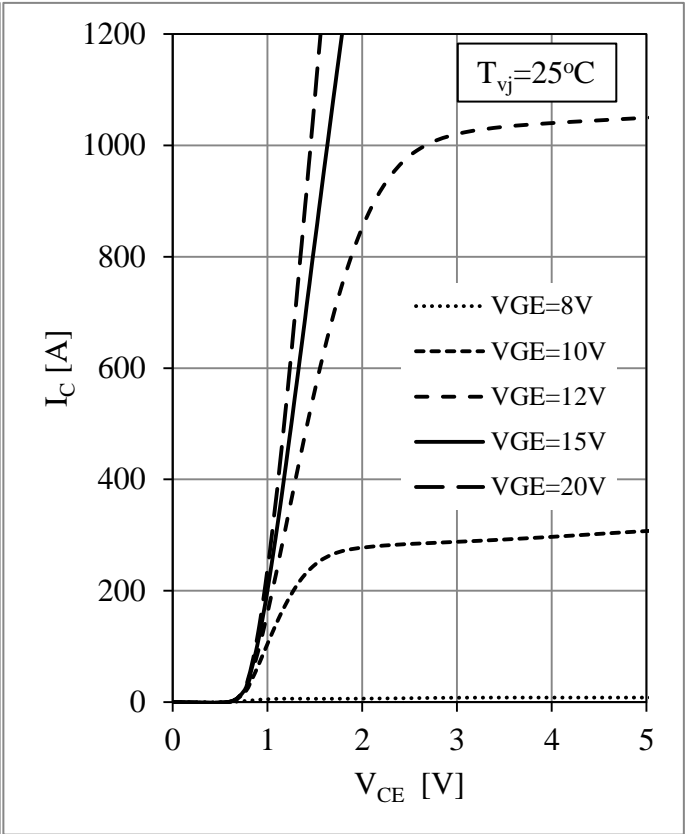

Fig 2. IGBT Output Characteristics

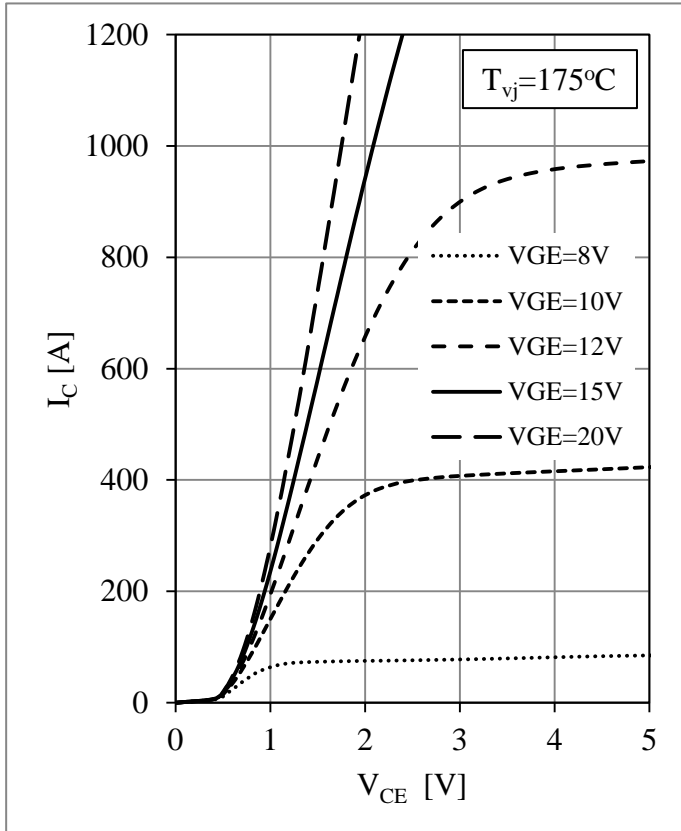

Fig 3. IGBT Output Characteristics

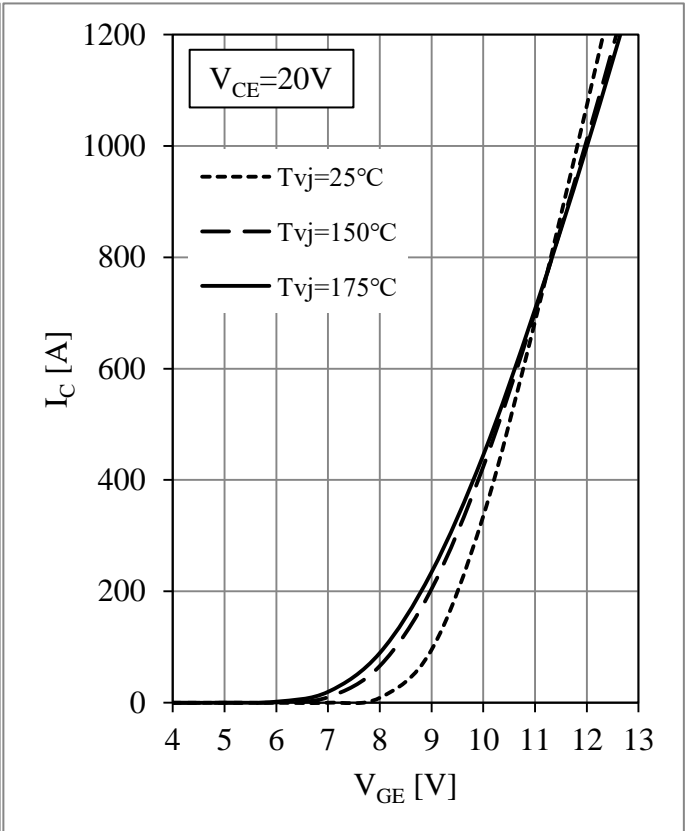

Fig 4. IGBT Transfer Characteristics

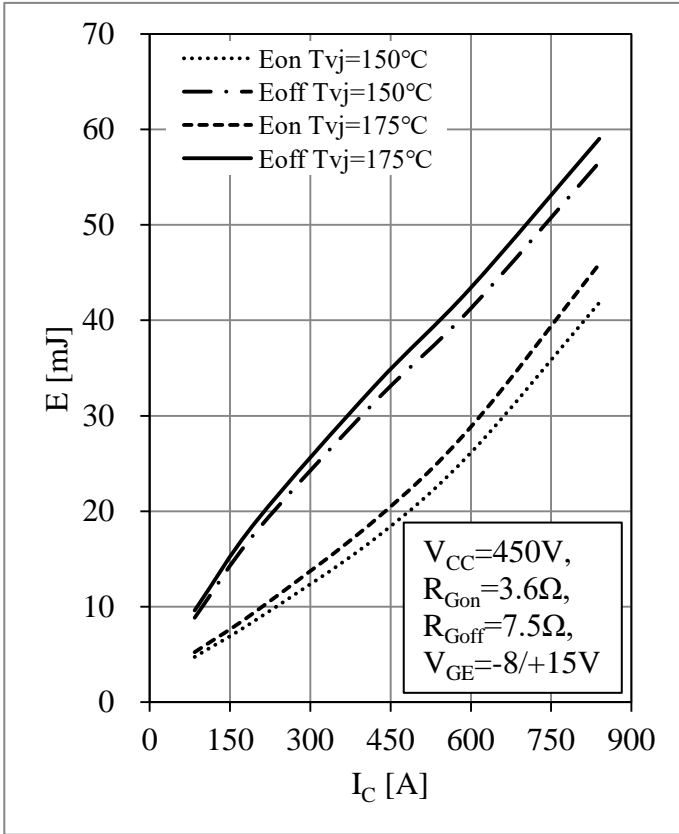

Fig 5. IGBT Switching Loss vs. I_C

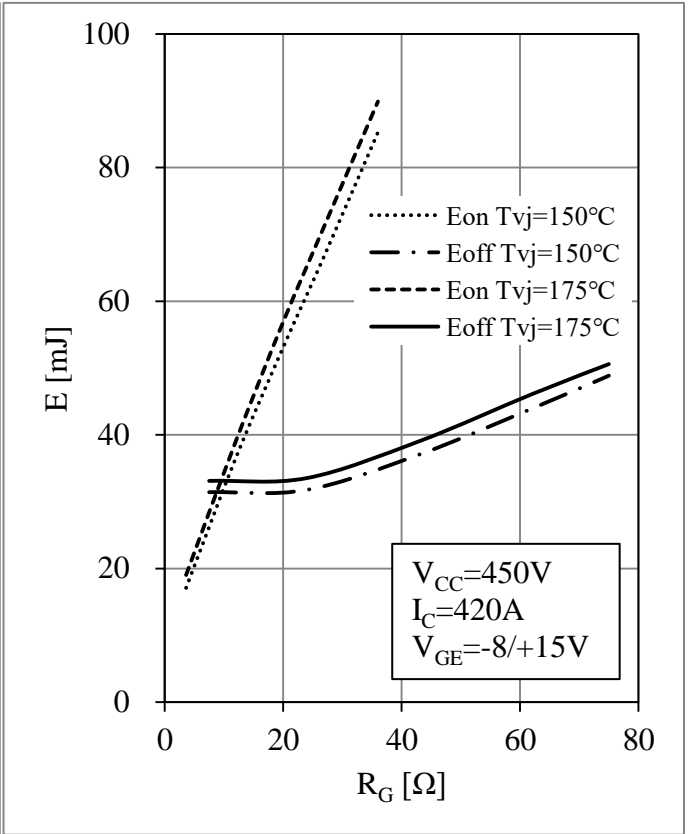

Fig 6. IGBT Switching Loss vs. R_G

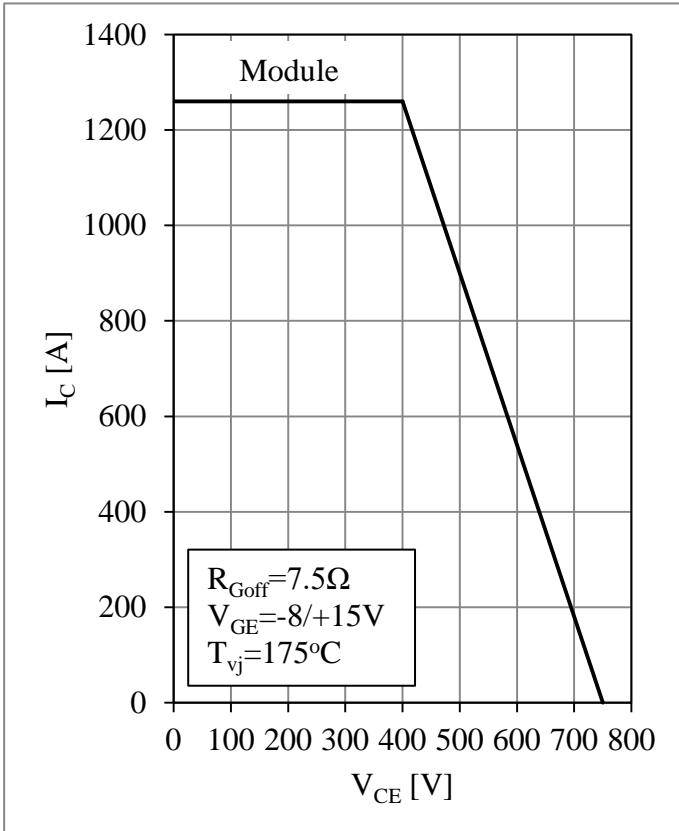

Fig 7. RBSOA

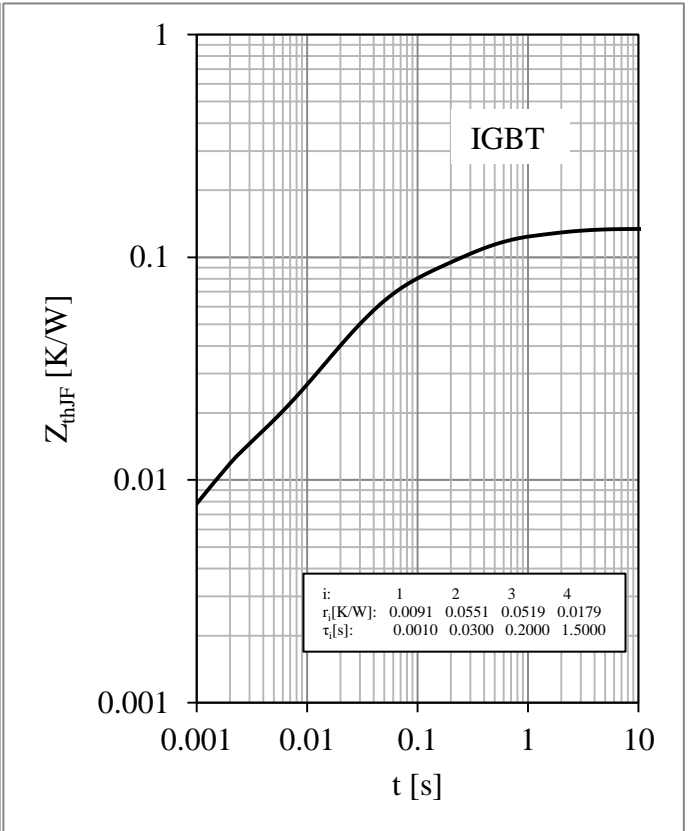

Fig 8. IGBT Transient Thermal Impedance

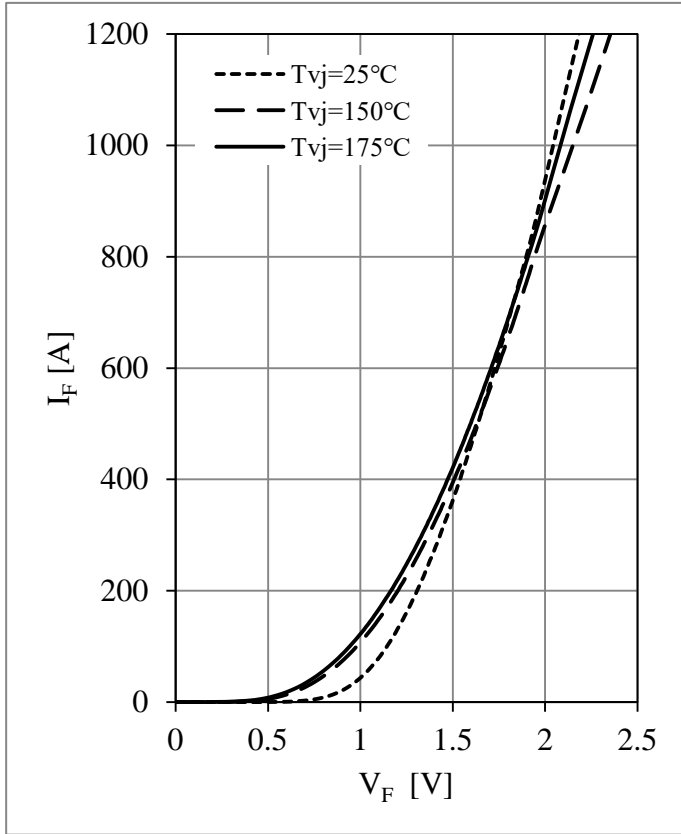

Fig 9. Diode Forward Characteristics

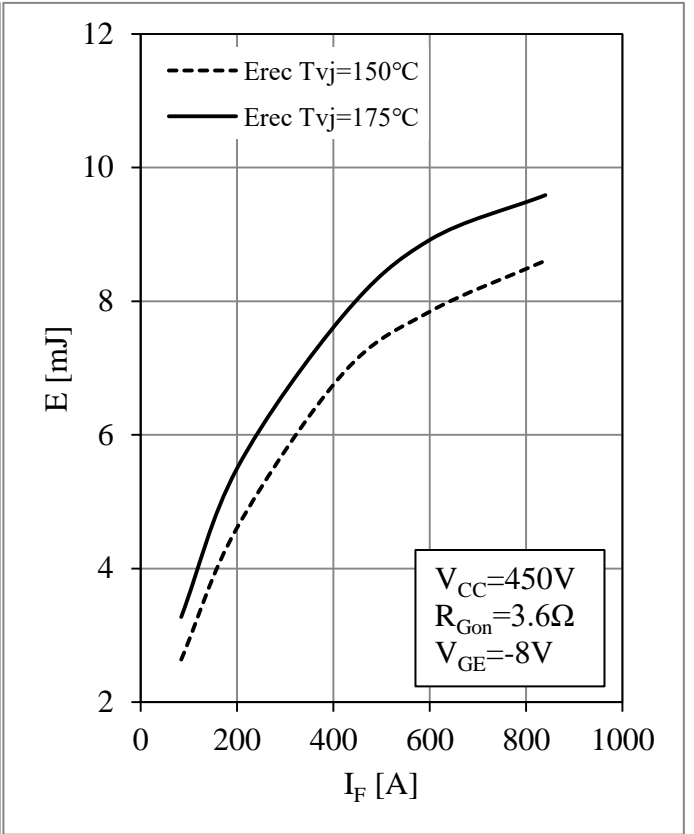

Fig 10. Diode Switching Loss vs. I_F

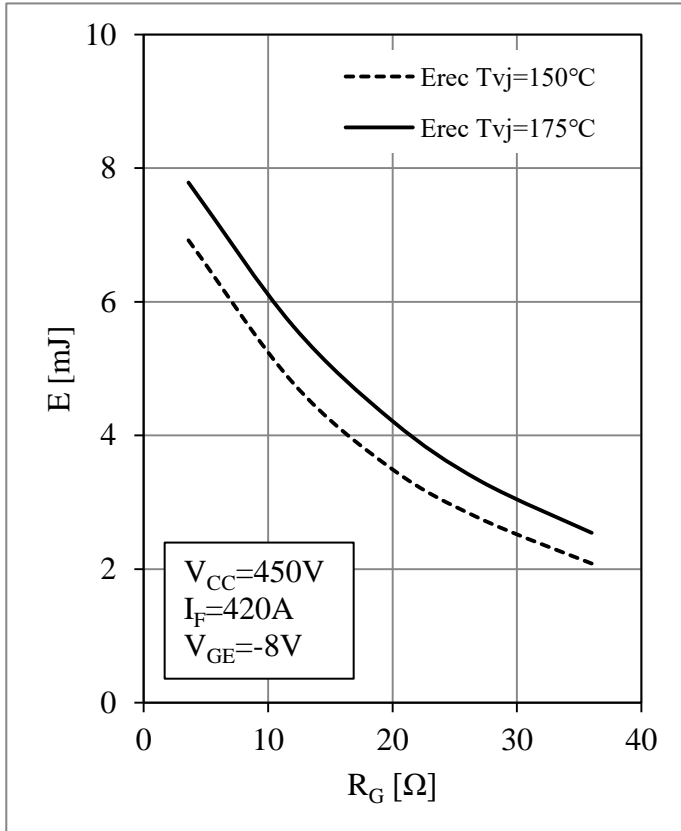

Fig 11. Diode Switching Loss vs. R_G

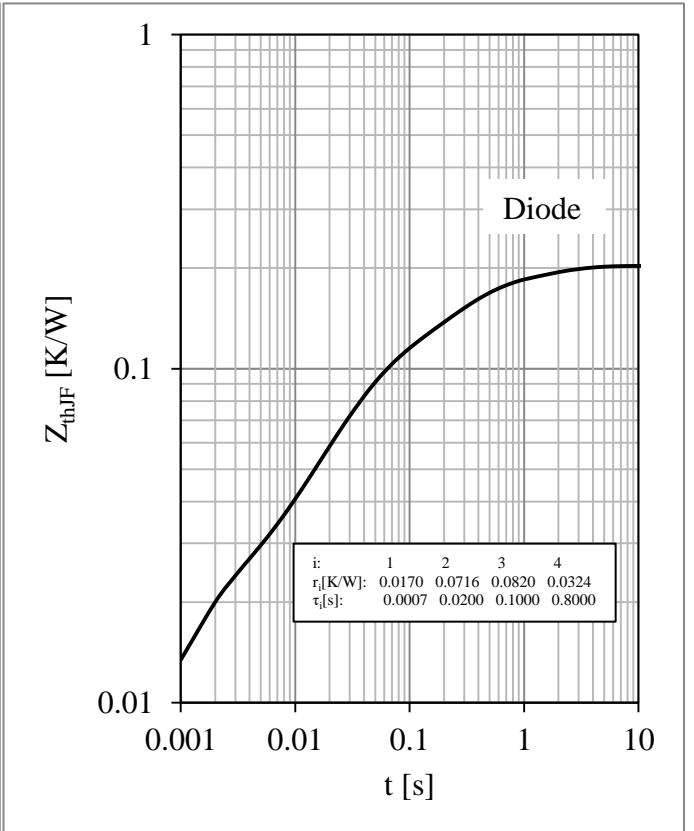

Fig 12. Diode Transient Thermal Impedance

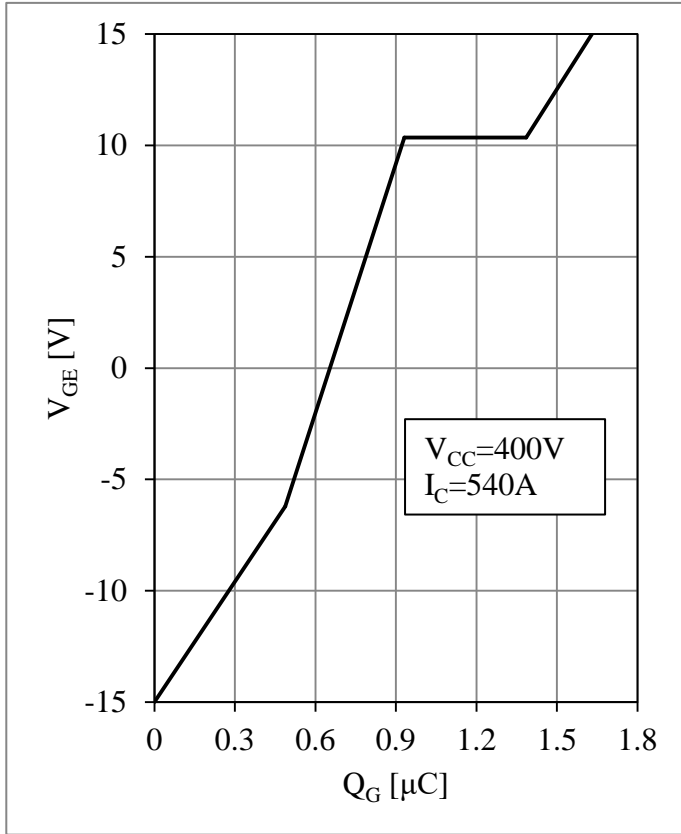

Fig 13. IGBT Gate Charge Characteristic

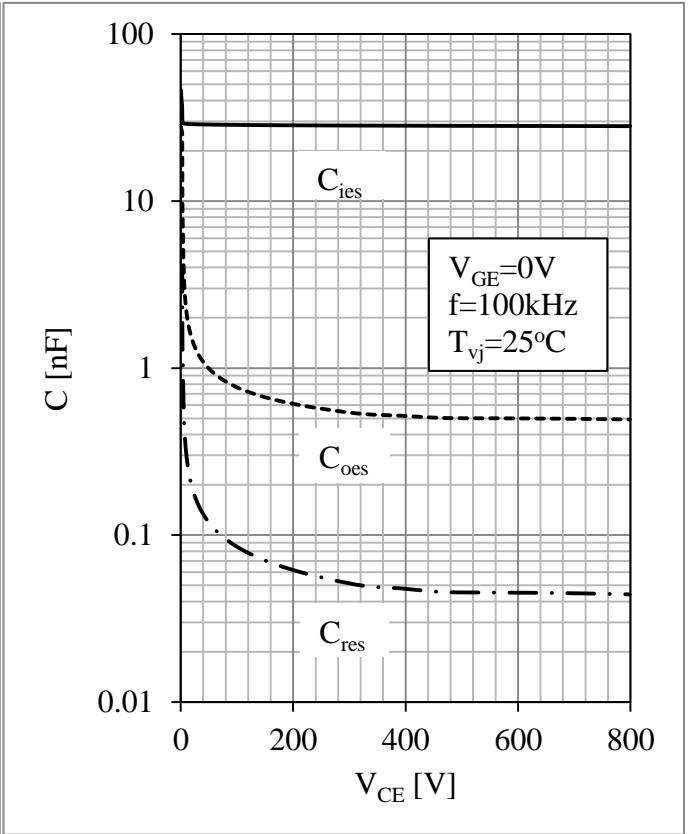

Fig 14. IGBT Capacity Characteristic

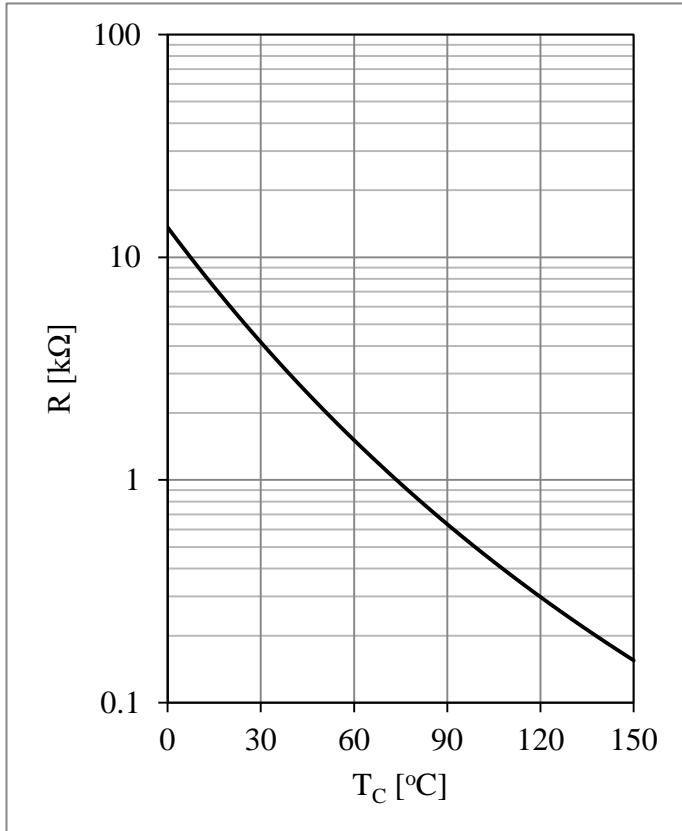
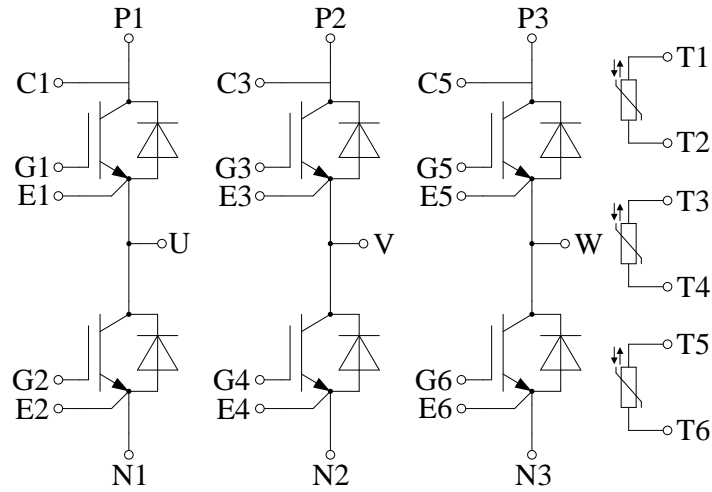

Fig 15. NTC Temperature Characteristic

Circuit Schematic



Package Dimensions

Dimensions in Millimeters

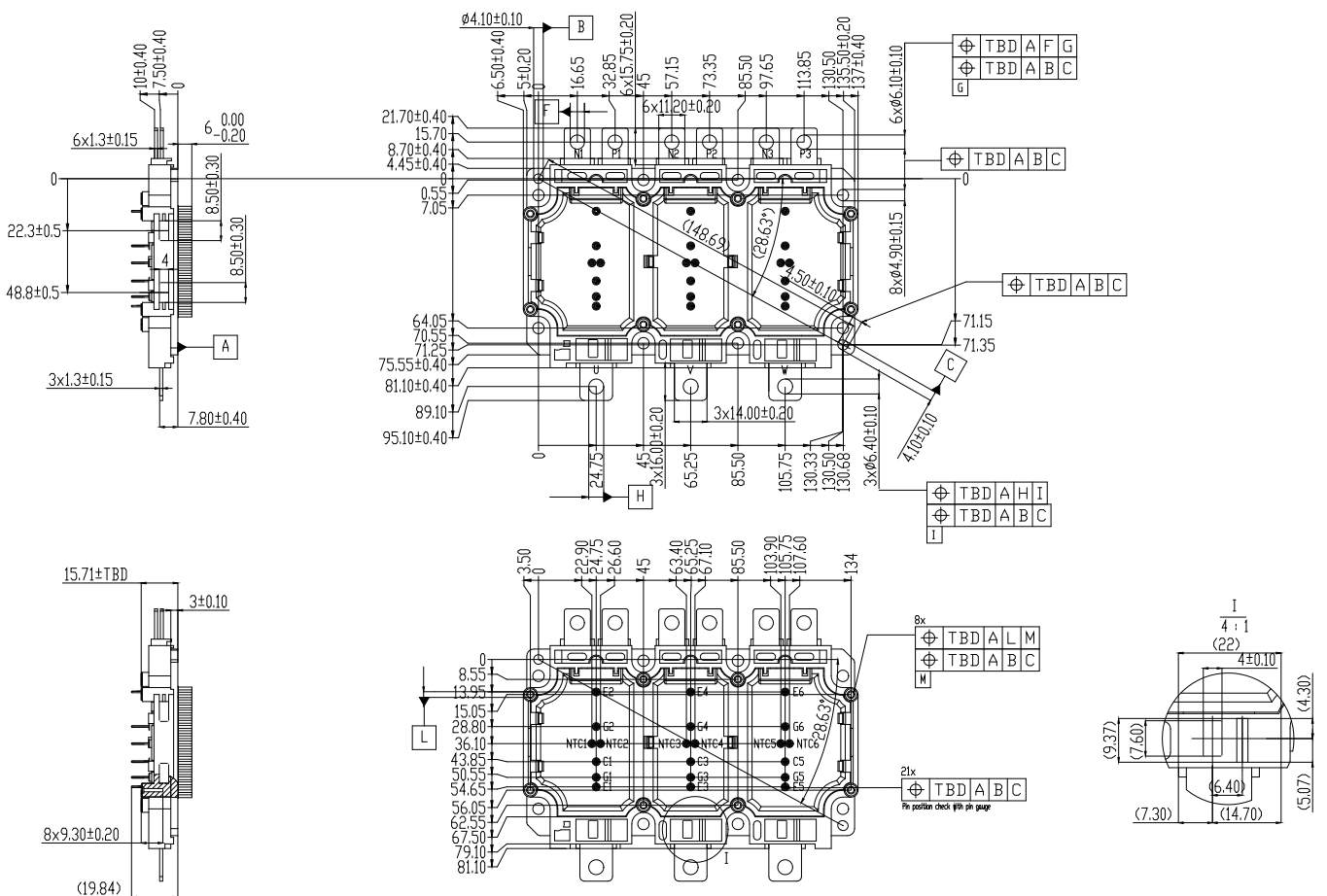

Terms and Conditions of Usage

The data contained in this product datasheet is exclusively intended for technically trained staff. you and your technical departments will have to evaluate the suitability of the product for the intended application and the completeness of the product data with respect to such application.

This product data sheet is describing the characteristics of this product for which a warranty is granted. Any such warranty is granted exclusively pursuant the terms and conditions of the supply agreement. There will be no guarantee of any kind for the product and its characteristics.

Should you require product information in excess of the data given in this product data sheet or which concerns the specific application of our product, please contact the sales office, which is responsible for you (see www.powersemi.cc), For those that are specifically interested we may provide application notes.

Due to technical requirements our product may contain dangerous substances. For information on the types in question please contact the sales office, which is responsible for you.

Should you intend to use the Product in aviation applications, in health or live endangering or life support applications, please notify.

If and to the extent necessary, please forward equivalent notices to your customers.
Changes of this product data sheet are reserved.